

ePMP™ 6 GHz 4x4 Sector Antenna

QUICK LOOK:

- **High-performance sector antennas designed by Cambium Networks to maximize ePMP point-to-multipoint performance.**
- **Frequency Range 5.9 to 7.125 GHz**

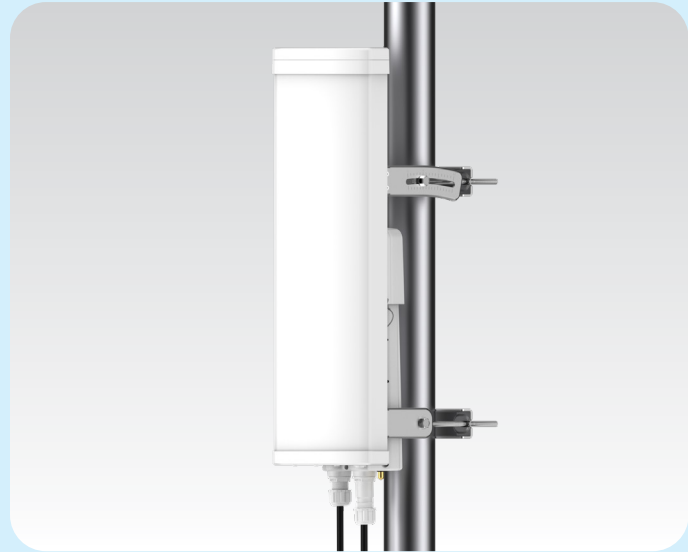

Cambium Networks has deployed millions of radios around the world achieving unparalleled degrees of scalability and performance. A key aspect to a successful point-to-multipoint deployments is the antenna selection that is optimized to maximize the overall system gain, spectral efficiency and interference rejection. Cambium Networks has designed a 6 GHz 4x4 MU-MIMO sector antennas especially well-suited for ePMP 4600 Access Points.

The 4x4 MU-MIMO 90° sector provides 18 dBi gain, 30 dB front-to-back ratio and the ability to form the beams necessary for grouping SM's for MU-MIMO performance. By forming these MU-MIMO groups, the RADIO effectively has two overlapping sectors enabling transmission to two SM's simultaneously. This antenna is ideal for 4-sector deployments and ABAB 2-channel reuse.



Use LINKPlanner to determine capacity and availability of Point-to-Multipoint networks

Key Advantages of Cambium Networks-designed ePMP Sector Antennas:

Frequency Reuse

Designed for ABAB channel reuse (two channels cover four sectors).

Consistent coverage

Excellent null fill and smooth azimuth patterns allow for broad geographical cover, including near the tower and out to the sector edges.

Ultra Wide Frequency Range

Designed for 6 GHz deployment worldwide covering 5.9 GHz to 7.125 GHz.

Designed for the Installer

Small, compact designs with integrated radio mounting for reliable and safe installations.

LINKPlanner Support

Cambium Networks planning tool offers precise 3D modeling of each sectors, elevation and azimuth, enabling predictable capacity and availability of each subscriber location.

ePMP™ 6 GHz 4x4 Sector Antenna

Antenna Specifications

Frequency Range	5.9 GHz to 7.125 GHz
Gain	18 dBi
3 dB Beamwidth Azimuth	65°
3 dB Beamwidth Elevation	5°
6 dB Beamwidth Azimuth	90°
Electrical Downtilt	-2°
Polarization	2 x Horizontal, 2 x Vertical
Port-to-Port Isolation	> 20 dB
Front-to-Back Ratio	30 dB
Maximum Input Power	5 W
Input Impedance	50 ohms
Mounting Connectors	4 x RP SMA

Antenna Specifications

Mounting Hardware	Included for mounting to mast diameters 5 cm to 10 cm (2 in to 4 in) -10° to +5° tilt Hardware included to connect ePMP access point to back of antenna body
Dimensions H x W x D	667 x 288 x 183 mm (26.3 x 11.3 x 7.2 in)
Weight	Antenna Body: 3.5 kg (7.7 lbs) w/ ePMP 4600 Access Point and Mounting Brackets: 5.6 kg (12.3 lbs)
Environmental	IP65
Radome Material	UV Protected Polycarbonate
Operating Temperature	-40°C to 60°C (-40°F to 140°F)
Wind Survivability	200 kph (124 mph)

Ordering Information

C060940D301A	ePMP 6 GHz 4x4 MU-MIMO Sector Antenna with Mounting Kit
---------------------	---



ePMP™ 6 GHz 4x4 Sector Antenna

ePMP 6 GHz 4x4 Sector Antenna Patterns

Channel 0 Vertical Polarization Azimuth

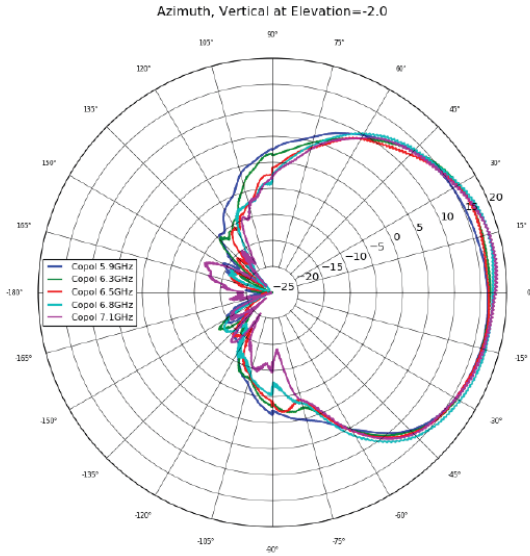

Channel 0 Vertical Polarization Elevation

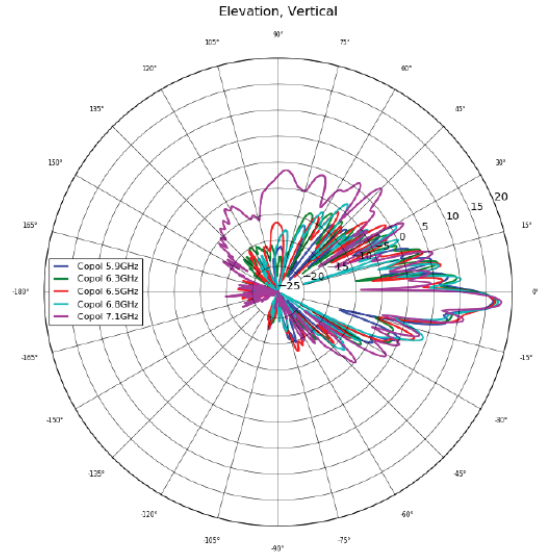

Channel 1 Horizontal Polarization Azimuth

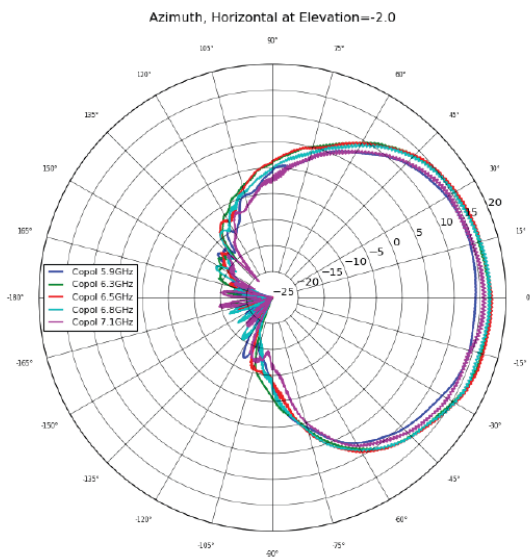

Channel 1 Horizontal Polarization Elevation

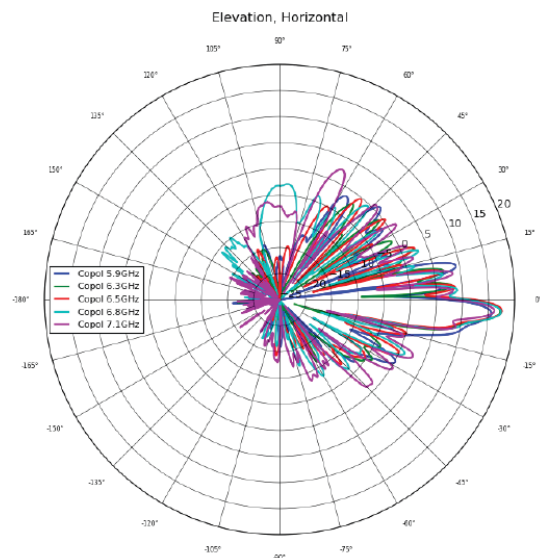

ePMP™ 6 GHz 4x4 Sector Antenna

ePMP 6 GHz 4x4 Sector Antenna Patterns

Channel 2 Vertical Polarization Azimuth

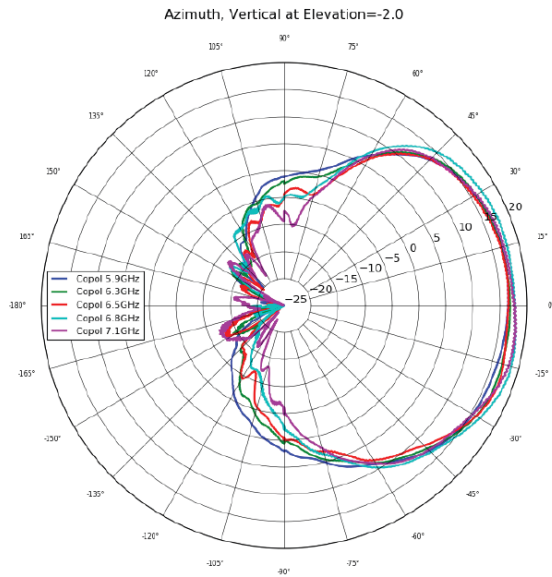

Channel 2 Vertical Polarization Elevation

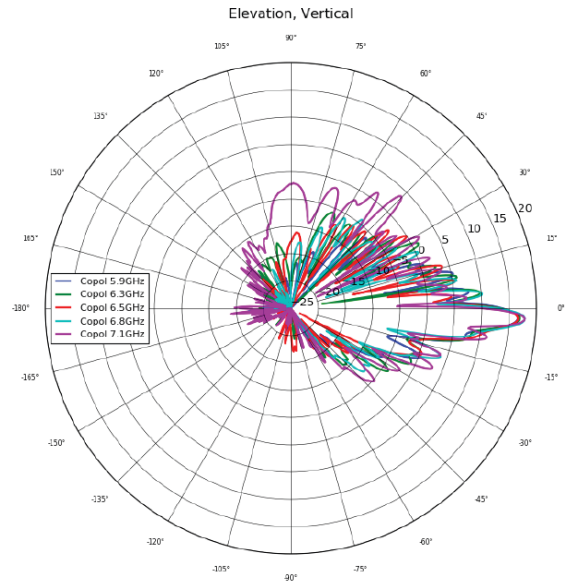

Channel 3 Horizontal Polarization Azimuth

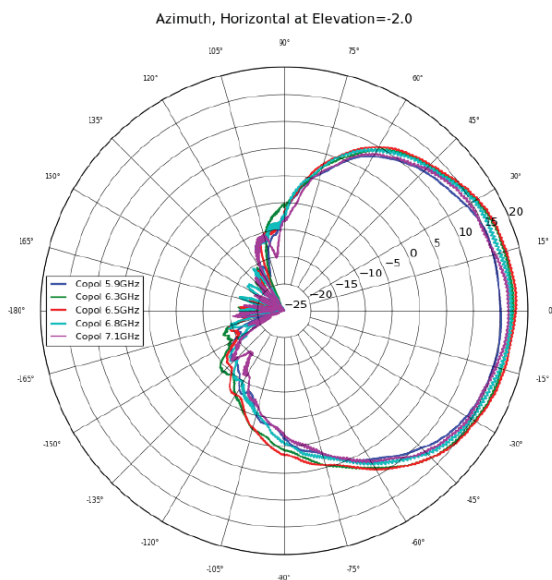

Channel 3 Horizontal Polarization Elevation

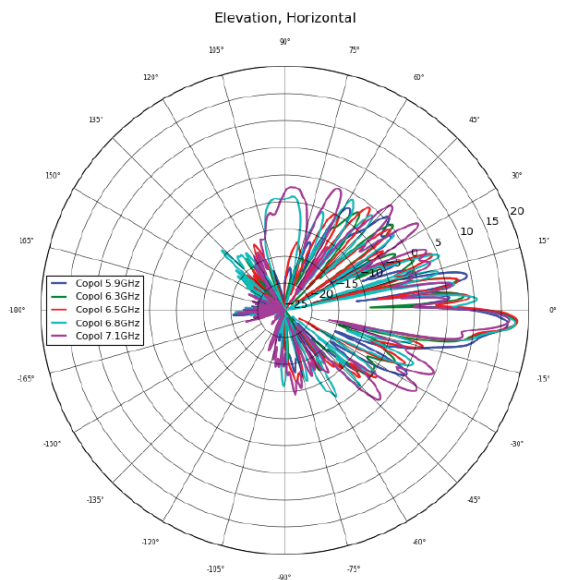

ABOUT CAMBIUM NETWORKS

Cambium Networks empowers millions of people with wireless connectivity worldwide. Its wireless portfolio is used by commercial and government network operators as well as broadband service providers to connect people, places and things. With a single network architecture spanning fixed wireless and Wi-Fi, Cambium Networks enables operators to achieve maximum performance with minimal spectrum. End-to-end cloud management transforms networks into dynamic environments that evolve to meet changing needs with minimal physical human intervention. Cambium Networks empowers a growing ecosystem of partners who design and deliver gigabit wireless solutions that just work.